

# CAROMA



## User Manual

**Urbane II Electronic Bidet Seat**  
**300071W | 300095W**

# Safety Precautions

## WARNING



### WARNING

- Battery is hazardous and is to be kept away from children (whether the battery is new or used)
- Battery can cause severe or fatal injuries in 2 hours or less if it is swallowed or placed inside any part of the body.
- Medical attention should be sought immediately if it is suspected the battery has been swallowed or placed in any part of the body.
- The supplied remote control has been tested and complies with the requirements of AS/NZS 62368.1: 2018. consumer goods (products containing button/coin batteries) safety standard 2020.
- Do not use recycled water.

## SAFETY PRECAUTIONS

**WARNING:** THIS TOILET DOUCHE MUST BE INSTALLED WITH APPROPRIATE BACKFLOW PROTECTION CONFORMING TO THE NATIONAL CONSTRUCTION CODE - VOLUME 3

INSTALLATION MUST BE IN ACCORDANCE WITH AS/NZS 3500. 2 AND PLUMBING CODE OF AUSTRALIA.

THIS TOILET DOUCHE SEAT IS SUPPLIED WITH DUAL CHECK VALVES AND IT ALSO HAS AN AIR GAP IN THE WATER TANK THAT IS COMPLIANT TO AS2845. 2 - WATER SUPPLY BACKFLOW PREVENTION.

NOTE: LOCAL AUTHORITIES MAY HAVE VARYING REQUIREMENTS. CHECK TO CONFIRM IF A RPZ VALVE IS REQUIRED.

**Caroma will not be liable for any loss arising from failure to comply with the following:**

1. This product is an “I” type electrical appliance and must be safely connected to the grounding system.
2. This product is an electrical appliance and should not be installed in a location where it can come in contact with splashing water, e.g. close to a shower or a high temperature location.
3. If the power supply cord gets damaged, do not use it until it has been repaired by a qualified electrician.
4. The appliance should be permanently connected to the water supply.
5. The Portable Residual Current Device (PRCD) is supplied as part of the power supply cord and must be reliably fixed.

**To avoid the risk of electric shock, short circuit or fire, NEVER perform the following:**

1. Do not insert or remove the power plug with wet hands.
2. The power supply must comply with local regulations.
3. Do not turn the product upside down.
4. Do not distort or bend the flexible water inlet hose.

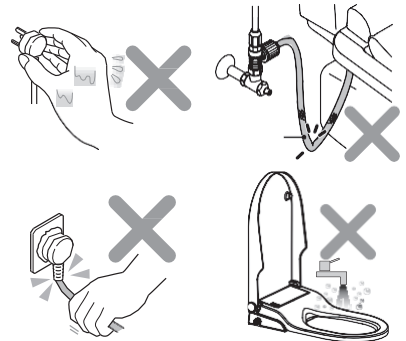

**GWA**  
Bathrooms & Kitchens

**Australia**  
Caroma Industries Ltd  
ABN 35 000 189 499

1 Melito Court, Prestons NSW 2170  
Customer Care Phone: 13 14 16  
[www.caroma.com.au](http://www.caroma.com.au)  
[www.methven.com](http://www.methven.com)

**New Zealand**  
GWA Group (NZ) Ltd  
NZBN 9429040452203

41 Jomac Place, Avondale, New Zealand  
Customer Care Phone: 0800 804 222  
[www.caroma.co.nz](http://www.caroma.co.nz)  
[www.methven.co.nz](http://www.methven.co.nz)

**Caution** - the bidet and remote control operate with batteries. It has a possibility to interfere with pacemakers, defibrillators or other medical devices which is used for assistance. For safety reasons, it is advised that a certain safe distance is to be always kept between the bidet and the medical device.

Date of Issue: 09/05/2026  
Rev No.3

# Technical Specification

MODEL		300071W
Wash	Rear Wash	●
	Female Wash	●
	Massage	●
	Adjustable Water Temperature	5 Steps (Default 3rd)
	Adjustable Flow Rate	5 Steps (Default 3rd)
	Adjustable Spray Position	5 Steps (Default 5th)
Drying/ Warm Air	Air Drying	●
	Adjustable Air Rate	5 Steps (Default 3rd)
	Adjustable Dryer Temperature	5 Steps (Default 3rd)
Heated Seat	Heated Seat	●
	Adjustable Seat Temperature	5 Steps (Default 3rd)
Hygiene	Deodorizer	●
	Nozzle Automatic Cleaning	●
	Nozzle Manual Cleaning	●
Descaling		●
Display Screen		●
Remote Control		●
Night Light		●
Open Cover/Seat Automatically		●
Water Supply Connector		G ¾ on unit with G ½ flex hose
Rated Voltage		AC 220 - 240V, 50/60HZ
Power		1200W*
Length of Powder Cord		1.8m
Water Supply Pressure		70~750kPa (0.7~7.5 Bar)
Water Supply Temperature		4~35°C
Ambient Temperature		4~40°C
Protection Degree		IPX4
Wash Device	Flow Rate	350~650 ml/min
	Water Temperature	31~39°C
	Wash Cycle Time	3 minutes
	Heating Mode	Tank
	Water Tank Volume & Water Tank Heater Power	800ml, 1200W
	Safety Device	Thermal Cutoff Fuses\Liquid
	Backflow Prevention	Air Gap of AB Type
Dry Device	Speed Of Air	≥4m/s
	Dryer Power	350W
	Dry Cycle Time	3 Minutes
	Warm Air Temperature	35~50 °C
	Safety Device	Thermal Cutoff Fuses\Thermostat
Deodorization	Deodorization Mode	Diatom
	Deodorization Cycle Time	15 Minutes
Heated Seat	Heated Power	60W
	Seat Temperature	29~37°C
	Safety Device	Thermal Cutoff Fuses\Thermostat
Remote Control	Frequency Range	2400-2520MHz
	Maximum RF Output Power	-10dBm
	Type of Batteries	3V CR2032 (Not supplied)
	Number of batteries	Two Pieces
Protection Degree		IPX4
Other Safety Device		Residual Current Devices

\* The power consumption depends on the inlet water temperature, environment temperature, setting temperature.

# Bidet Dimensions

Unit: mm

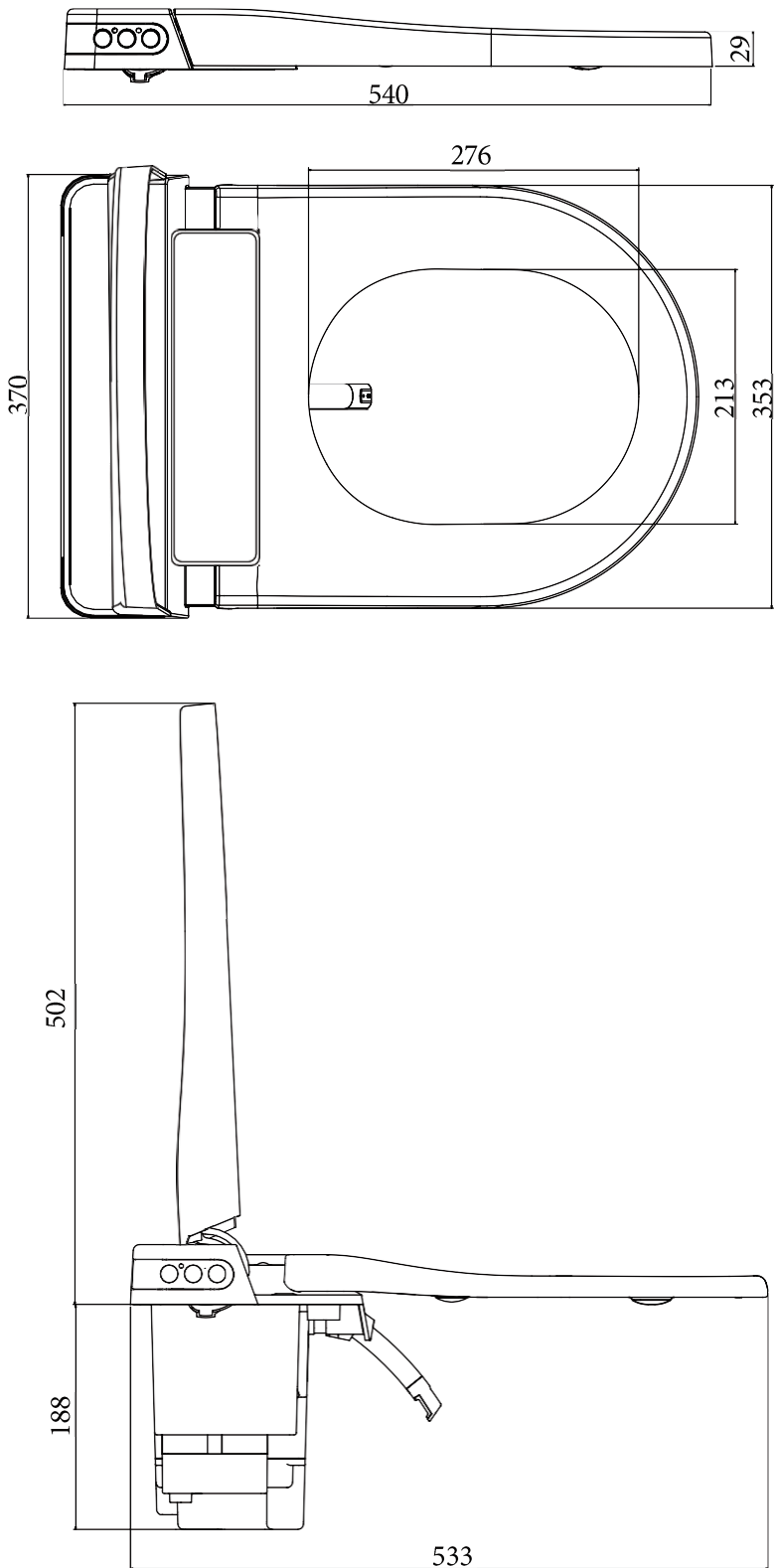

Overview

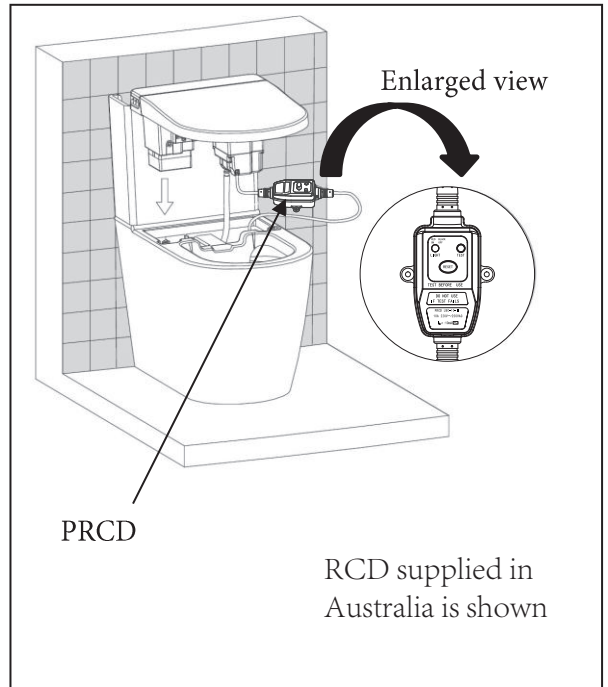
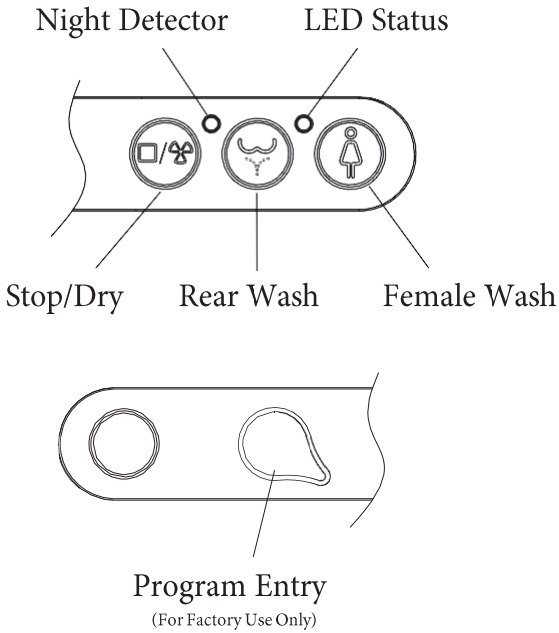
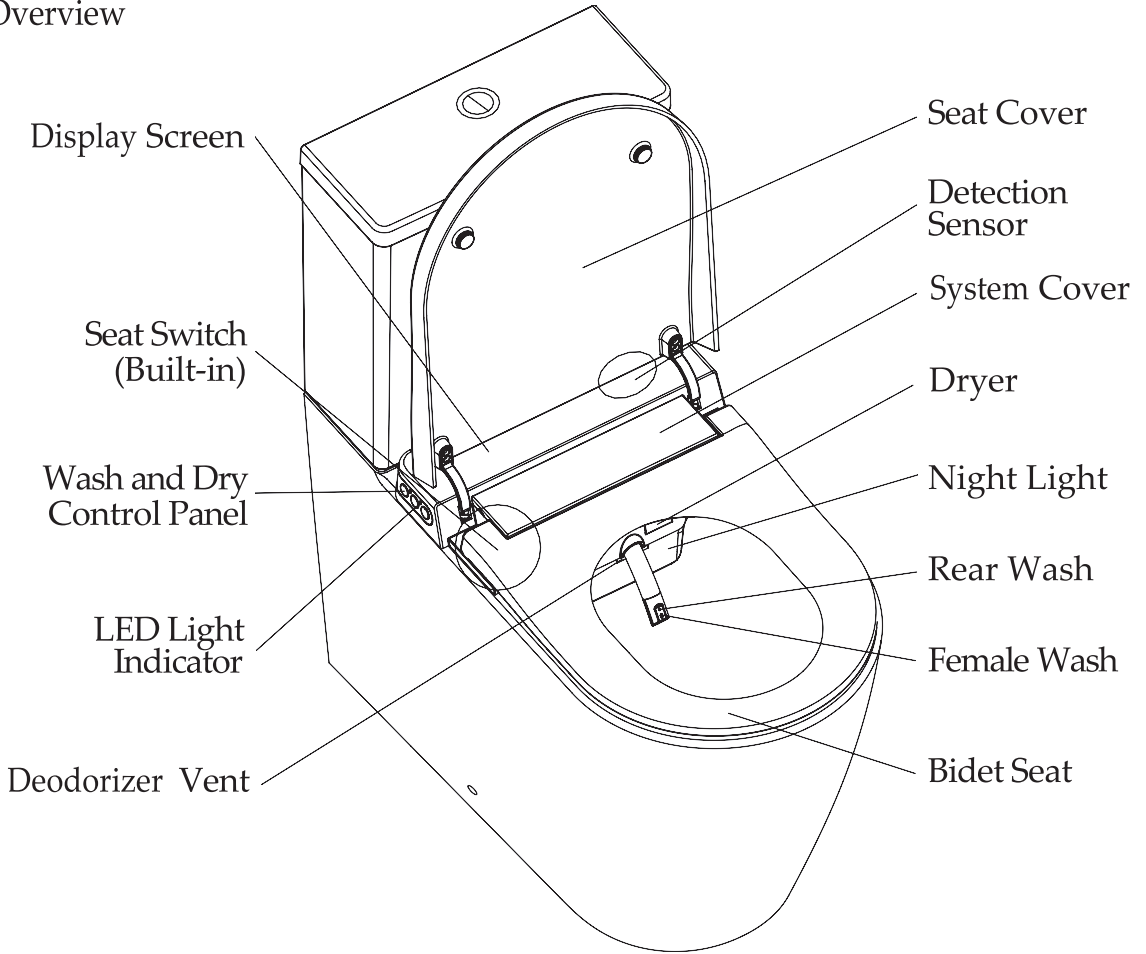

# Remote Control

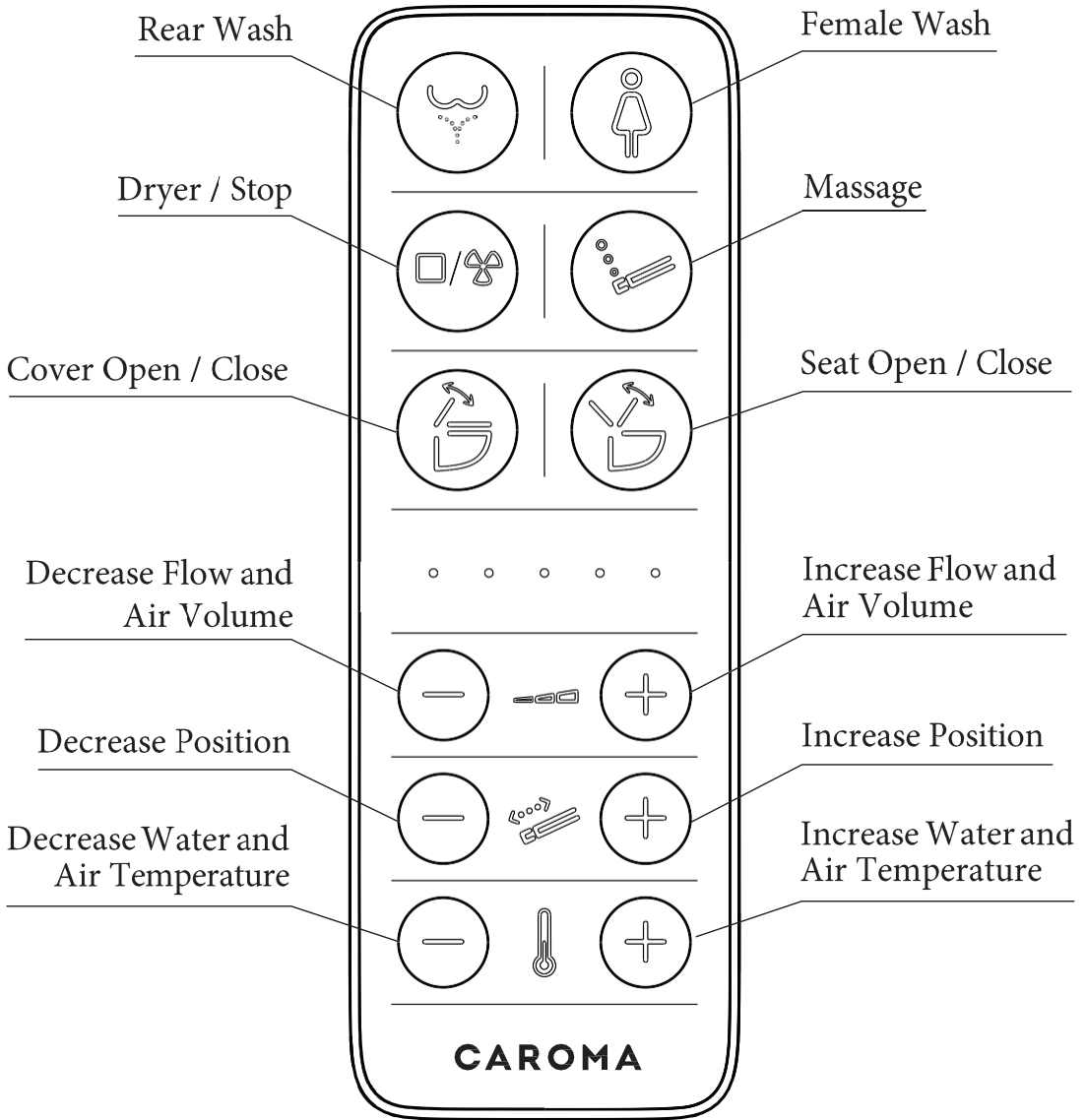

**300071W | 300095W**  
**Electronic Bidet Seat**  
**Remote Control**

1. The remote control requires 2 batteries (3V CR2032). (Not supplied)
2. The remote control provided is only to be used for model 300071W / 300095W Urbane II Electronic Bidet Seat.

# Function Introduction

## Initialization

After connection to the power and water supply, press the 'RESET' button on the PRCD (refer pg. 5). Then please wait.

Note: In case of a power disruption, press the 'RESET' button on the PRCD again once the unit is connected back to the power.

Do not operate during this period. User needs to be seated for the bidet functions to operate after initialization.

## Wash Operation

Press the "Wash" button on the remote control to start the wash. It will automatically stop after 3 minutes; you can also stop washing by pressing the "Stop" button.

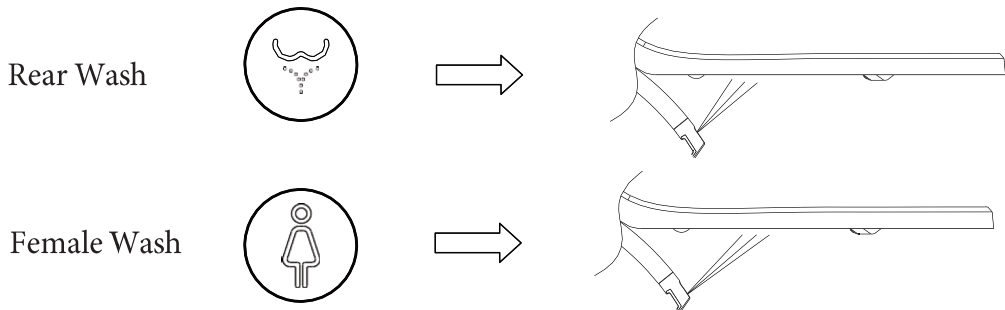

**Note:** While on Rear wash or Female wash mode, it will wash at the fixed position for about 10 seconds, and on movable wash mode it will wash for about 18 seconds, then it returns to the normal position.

OR - You can operate by pressing side seat buttons for wash operations.

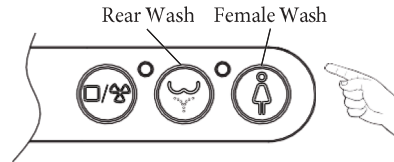

## Drying Operation

Please be seated.

To begin drying, press the "Dry / Stop" button to start drying (LED status: RED). It will automatically stop after 3 minutes, or you can press the "Dry / Stop" button to stop (LED status: ORANGE).

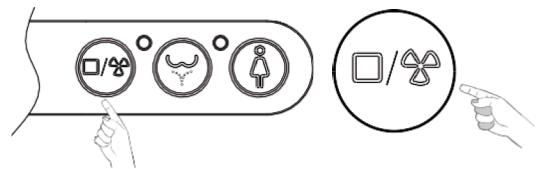

## Massage Operation

In the process of Rear or Female washing  
Repeatedly press the "Massage" button on the remote until you choose your desired spray mode.

**Close mode:** No indicator light is on

**Oscillating:** One indicator light is on

**Pulsating:** Two indicator lights are on Oscillating +

**Pulsating:** Three indicator lights are on

Remote control LEDs

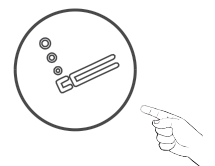
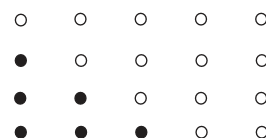

## Stop Operation

While using the Rear washing, Female washing or Drying functions,

Pressing the "Stop" button on the remote control **OR** pressing the "Dry / Stop" side button on the seat will stop the function.

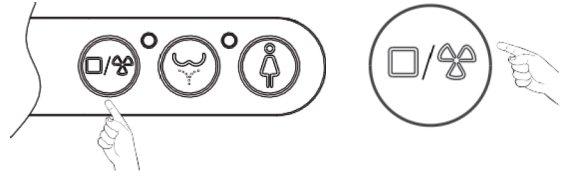

## Adjusting Water Flow Rate

In the process of rear washing or female washing, press the "flow adjustment" button on the remote control to adjust the flow rate.

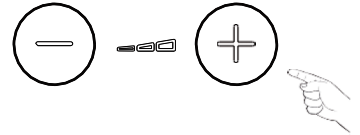

## Adjust Water Temperature

During Female/Rear Washing, press the "Increase" or "Decrease" button of "Adjust temperature" on remote control to adjust the Water Temperature.

Digital display function: when the water temperature is adjusted, the screen will display the water temperature accordingly.

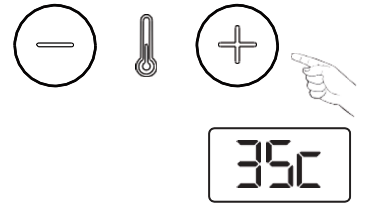

## Adjust Drying Air Temperature

During Drying, press the "Increase" or "Decrease" button to "Adjust temperature" on remote control to adjust the Air Temperature.

Digital display function: when air temperature is adjusted, the screen will display the air temperature accordingly.

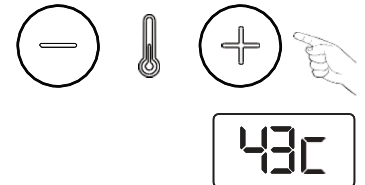

## Adjusting the Nozzle Position

In the process of rear washing or female washing, press "position adjustment" buttons on the remote control to adjust the nozzle position forward or backward.

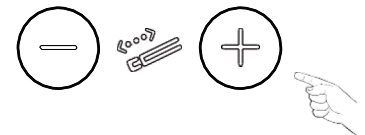

## Adjusting Drying Air Flow

During Drying, to select drying option, press "flow adjustment" buttons on the remote control to adjust the blower air flow rate.

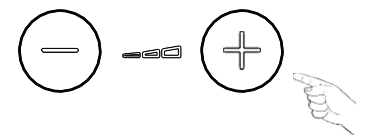

## Adjusting Temperature

### 1. Adjusting the Seat Temperature

Press and hold “+” or “-” button of “Adjust temperature” and press “Seat Open/Close” button to adjust the seat temperature.



#### Notes:

1. When the seat temperature is set, and the seat is unoccupied, the screen will display the set temperature.



2. If the seat temperature is set to “OFF”, the screen will display --C.

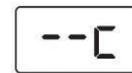

#### 5 seat settings

● ○ ○ ○ ○	29°C	1 LED
● ● ○ ○ ○	31°C	2 LEDs
● ● ● ○ ○	33°C	3 LEDs
● ● ● ● ○	35°C	4 LEDs
● ● ● ● ●	37°C	5 LEDs
○ ○ ○ ○ ○	off	0 LED

### 2. Anti Scald Setting

After 10 minutes of use or more of the bidet seat, you will notice that the temperature continues to be at its lowest level of 29° C.

To change temperature of the seat, activate the heating functions on the remote control.

## Cover / Seat Open or Close

Press the “Cover open/close” button on the remote control to open or close the cover, press the “Seat open/close” button to open or close the seat.

Cover open or close



Seat open or close



## Auto Cover Opening / Closing

Press and hold “+” or “-” temperature button and press “Cover open / close” on the remote control to adjust the different modes for the automatic open / close function

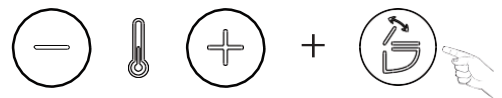

Short range detection mode is set as default. Led lights on the remote control indicate the following status.

Remote control LEDs

● ○ ○ ○ ○	OFF
● ● ○ ○ ○	Short range detection
● ● ● ○ ○	Long range detection

Range Mode

OFF
Short range detection
Long range detection

Digital Display Function

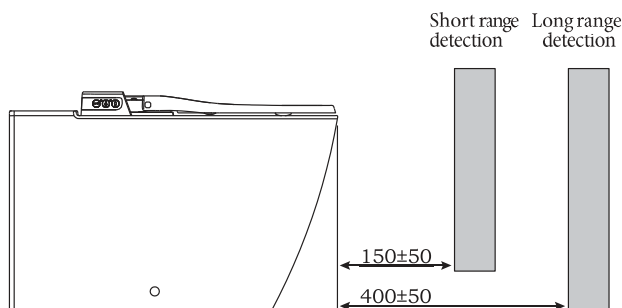

## Cover / Seat Open or Close

### Automatic mode

The function of automatic cover open/close, the cover will open automatically when the user detection sensor detects movement within the sensor range. The cover will close automatically after about 60 seconds when the user detection sensor does not detect any movement within the sensor range.



### Please remember!

1. When the user walks within the sensing area slowly, the sensing distance for cover opening/closing may be shortened. If the cover does not respond, please open or close the cover with the remote control or by hand.
2. The function of automatic cover open/close works only when the "Setting of cover open/close" on the remote controller is set to "On".
3. When any movement is detected in the toilet (such as opening and closing doors or fluttering curtains), the cover may open automatically. (If it continues to open by mistake due to the bathroom environment, the automatic seat open/close mode can be turned off on the remote control). When used by children, the user detection sensor may fail to detect due to height detection.
4. It is recommended not to open or close the cover/seat forcefully. Any extreme force to open or close the cover and seat manually could cause damage to the auto open and close modes, and this can cause a product function failure.

### Manual mode

Users can open or close the cover and seat directly by hands. When user intends to open or close the cover and seat under normal condition, the cover/seat will open or close automatically against the trend of motion. The user should not use force. Once being stopped by any obstacle during motion, the cover or seat will stop moving automatically.

## Night Light Setting

Smart mode for the night light is set as default. Press and hold "Increase" or "Decrease" button of "Adjust temperature" + repeatedly press "Decrease" button of "Adjust Position" on the remote control to change modes.

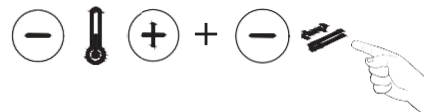

**Off mode:** when one indicator light is on  
**Always on:** when two indicator lights are on  
**Smart mode:** when three indicator lights are on

Remote control LEDs

Remote control LEDs	Mode
● ○ ○ ○ ○	Close Mode
● ● ○ ○ ○	Always on Mode
● ● ● ○ ○	Smart Mode

NOTE: When it's in "smart" mode, the night light switches on in a dark environment and switches off in a bright environment.

## Deodorize Setting

Smart mode for the deodorization by default. It is on when the user sits down, and it will be off after one minute when the user leaves. If there is no operation of washing or drying during being seated, this mode will cancel after 15 minutes.

Press and hold "Increase" or "Decrease" button of "Adjust temperature" + repeatedly press "Increase" or "Adjust Position" on the remote control to turn the deodorization function on and off.



**Off mode:** when one indicator light is on

**On mode:** when two indicator lights are on

Remote control LEDs	Mode
● ○ ○ ○ ○	Close Mode
● ● ○ ○ ○	Smart Mode

## Display Function

When a person is close or during uses, the display will illuminate. It shows seat temperature by default. When seated, the display screen shows the seat temperature. When it starts washing, the display screen shows current water temperature. When it starts drying, the display screen shows current air temperature. 5 seconds after washing or drying stops, the display screen will again show the seat temperature.

### Changing temperature display units

The display window shows degrees Celsius by default.

Press and hold "Increase" or "Decrease" button for "Adjust temperature" + press "Massage" on remote control to change the display from degrees Celsius to degrees Fahrenheit.

**Fault warning:** The display screen will show the Fault code as per "Fault warnings and codes V0.2". The display screen light will not change but the status LED will flash in red and with sound warning. It will return to normal when the fault is solved.



## LED Status

When seated (LED status: Orange), press "Rear wash" or "Female wash" side buttons to start the washing (LED status: Red).

It will automatically stop after 3 minutes, or you can press "Stop/ Dry" side button to stop washing (LED status: Orange).

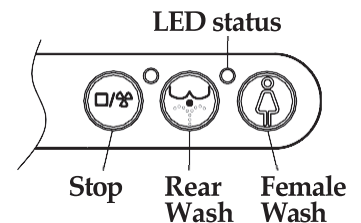

## Power Standby Setting

When not seated, continue pressing the side buttons for more than 6 seconds, it will go into power standby mode. Press again on the side buttons for more than 6 seconds to restart the functions.

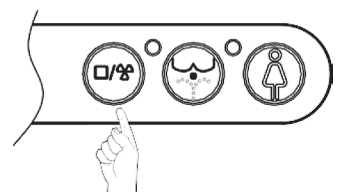

## Sound Setting

The sound is on by default. There will be a BEEP when the bidet has received commands or signals. Press and hold the 'Increase' or 'Decrease' button for 'Adjust Temperature', then press the 'Front Wash' button to toggle the sound ON or OFF.

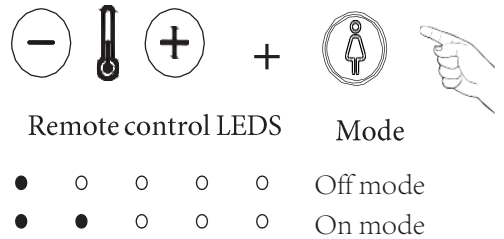

## Power Saving Mode

Intelligent power saving mode and timed power saving mode.

Intelligent power saving mode: The product will detect when not in use, seat temperature will stay at the lowest level.

Timed power saving mode: Set unused time range (6 or 9 hours), seat will not be heated. This mode will automatically exit after 6 or 9 hours.

Intelligent + Timed power saving mode: If the two modes are set at the same time, the smart power saving mode could work even if not in the timed power saving period. Press and hold "Increase" or "Decrease" button to "Adjust temperature" + repeatedly press "Increase" button of "Adjust Flow" to change mode.

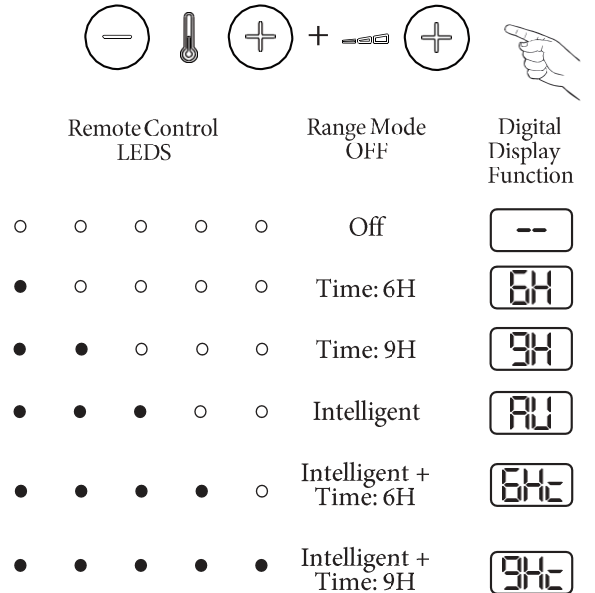

## Draining the Water Tank

- The water and power must be turned off before you disassemble the E-Bidet
- Do not invert or tilt it before you finish draining the water tank.

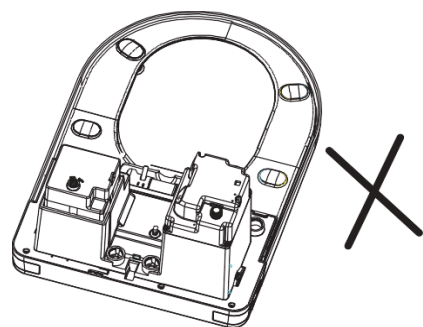
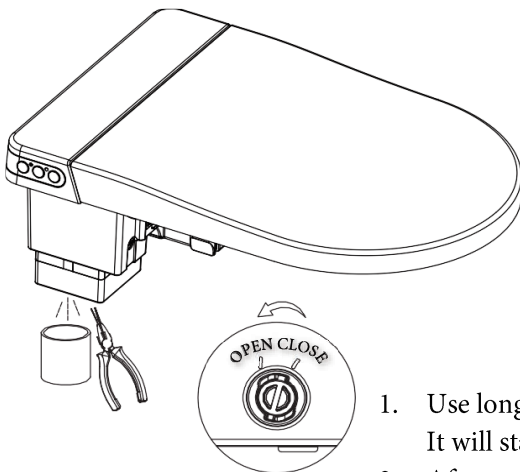

1. Use long pliers to hold, rotate and pull out the drain plug. It will start to drain.
2. After completing the drain process, insert the plug back and rotate to "CLOSE".

## Remote Control Pairing Setting

### Important:

- Bidet seat can be operated with its remote controller **without** pairing and pairing required **only** if you have more than one bidet seats installed close enough to each other where the bidet seat can react to the remote-control units of the other bidets installed.
- If you are in the middle of the pairing process and want to start all over again, press “Stop/Dry” button on remote control three times before going back to step 1.
- Once started, follow all the steps listed below to complete the pairing as leaving it halfway through may stop the bidet seat responding to the remote-control unit.
- In case the remote-control unit was replaced after pairing, it must be paired with the bidet.

### Note:

If the Method-1 does not pair the remote with the bidet seat, this means remote controller has a different firmware than the default. Please try Method 2 or Method 3 in this case.

### Method-1

1. When the bidet is unoccupied, press and hold "Female wash" button for more than 6 seconds until all five LED lights are on, then release the "Female wash" button.

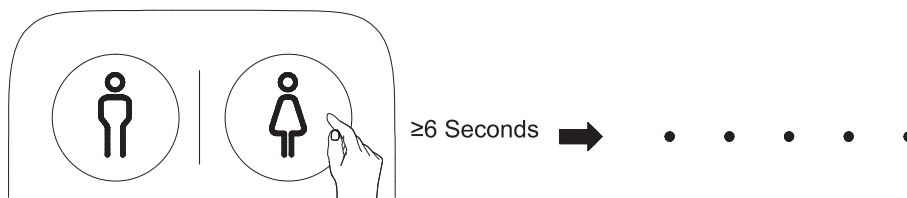

2. Press "Stop/Dry" side button on the bidet, when there is "long beep" sound, the setting is finished.

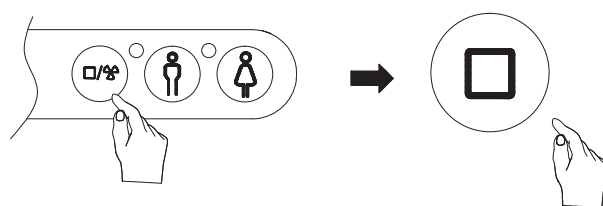

### Method-2

1. When the seat is unoccupied, press and hold "Decrease" (-) button of "Adjust temperature" and "Stop/Dry" button on the remote control until LEDs on remote-control no longer changes its light pattern, then release the "Decrease" (-) button of "Adjust temperature" and "Stop/Dry" button. Now remote control has entered the code matching mode.
2. Press “Increase” (+) or “Decrease” (-) button of “Adjust Flow” to choose different code for each bidet seat – see below image ‘Code Setting’ as an example.  
Bidet seat starts a red blinking LED now.
3. Press “Stop/Dry” side button on bidet seat, then press “Stop/Dry” button on the remote control. Bidet makes a long single ‘BEEP’. Blinking red LED on bidet changes to steady green LED. Pairing is completed.

### Method-3

1. When the seat is unoccupied, press and hold "**Decrease**" (-) button of "**Adjust temperature**" and press "**Stop/Dry**" button on the remote control until all 5 LED lights turn on and then all LEDs go OFF except the one LED which will go blinking or stay steady. Then release the "**Stop/Dry**" button. Press "**Decrease**" (-) button of "**Adjust flow**", then press "**Increase**" (+) button of "**Adjust flow**". Now remote control has entered the code matching mode.
2. Release the "**Decrease**" (-) button of "**Adjust temperature**" and press "**Increase**" (+) or "**Decrease**" (-) button of "**Adjust Flow**" to choose a different code for each shower toilet. See below image 'Code Setting' as an example.  
Bidet seat starts a red blinking LED now.
3. Press "**Stop/Dry**" side button on bidet seat, then press "**Stop/Dry**" button on the remote control. Bidet makes a long single 'BEEP'. Blinking red LED on bidet changes to steady green LED.  
Pairing is completed.

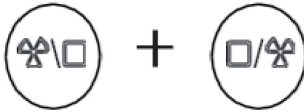
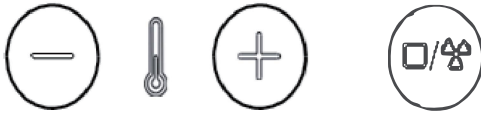

### Code Setting:

Shown below are some examples of different codes you can choose.

Different LED patterns represent different codes. Note that only few codes are listed below.

Code-1 (example only)

Code-2 (example only)

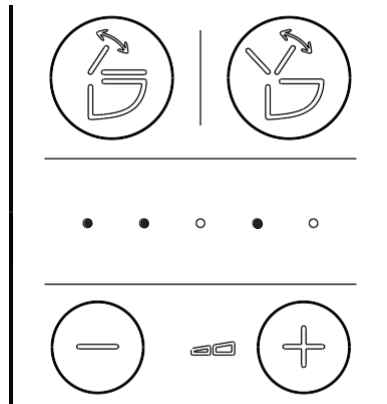
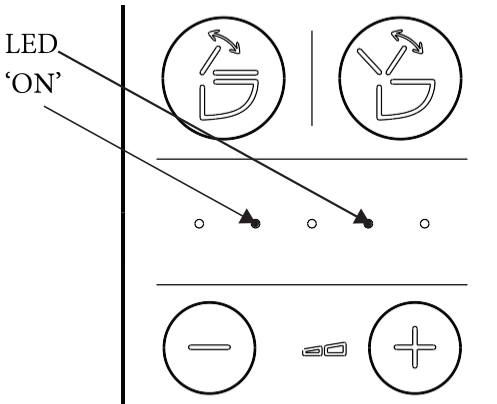

Code-3 (example only)

Code-4 (example only)

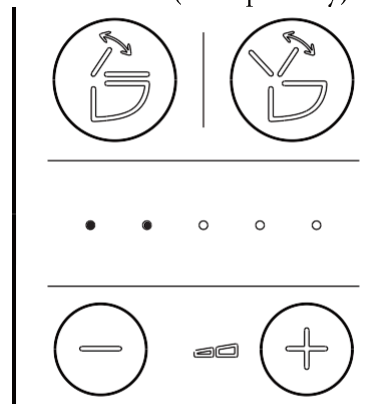
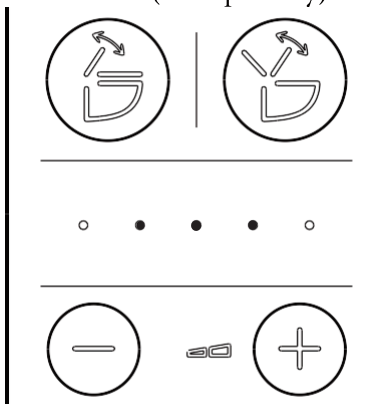

# Nozzle Cleaning

The nozzle will be automatically cleaned before and after washing.

## The operation of manual cleaning is as follows

Open the cover and seat, press the “Stop” and “Female Wash” side buttons at the same time, or press and hold “Increase”/” Decrease” of temperature adjustment + press “decrease” of flow volume adjustment on the remote control. The nozzle will come out with water and the nozzle head can be removed and cleaned manually. The nozzle will retract automatically after 5 minutes, or you can press the “Stop” button and the nozzle will retract itself to the normal position.

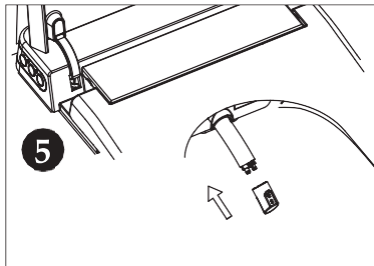
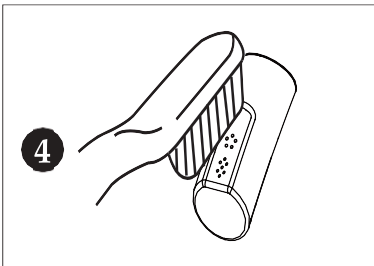
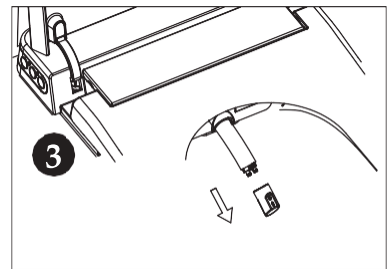
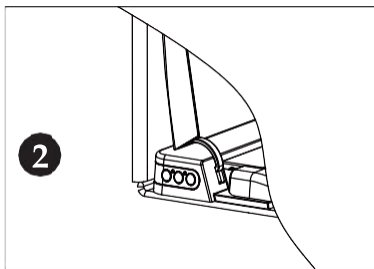
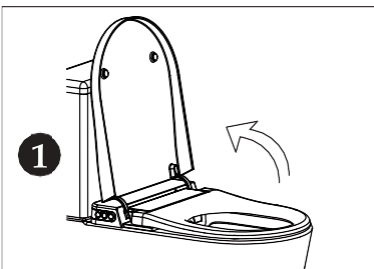
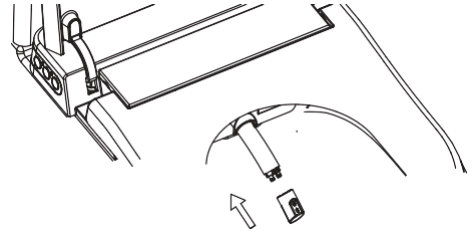

## Replacing the filter

The seat will need to be lifted off to access the filter. The filter has a service life of 6 months. This is depended on the water quality. The filter should be replaced when the water flow is restricted.

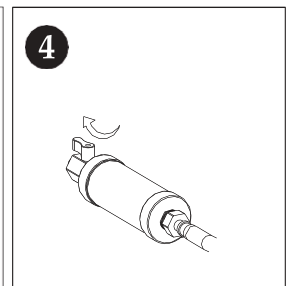
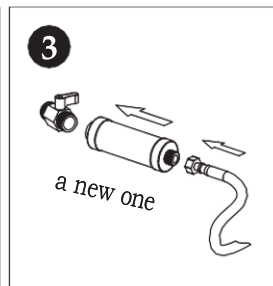
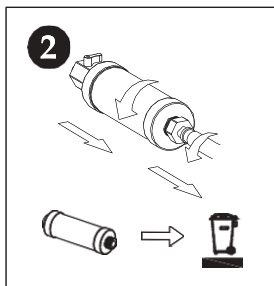
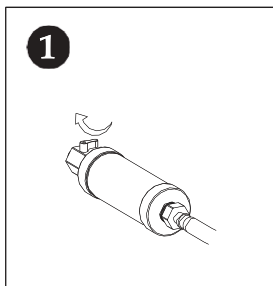

## Care and Maintenance

Maintenance interval	Maintenance activity
Weekly	Clean all surfaces and corners. Clean the spray nozzle if required. See “Nozzle cleaning”
Every half year	Replace the filter if required.
Every year	Descal the device. See “Descaling the device”

### Cleaning agents and tools

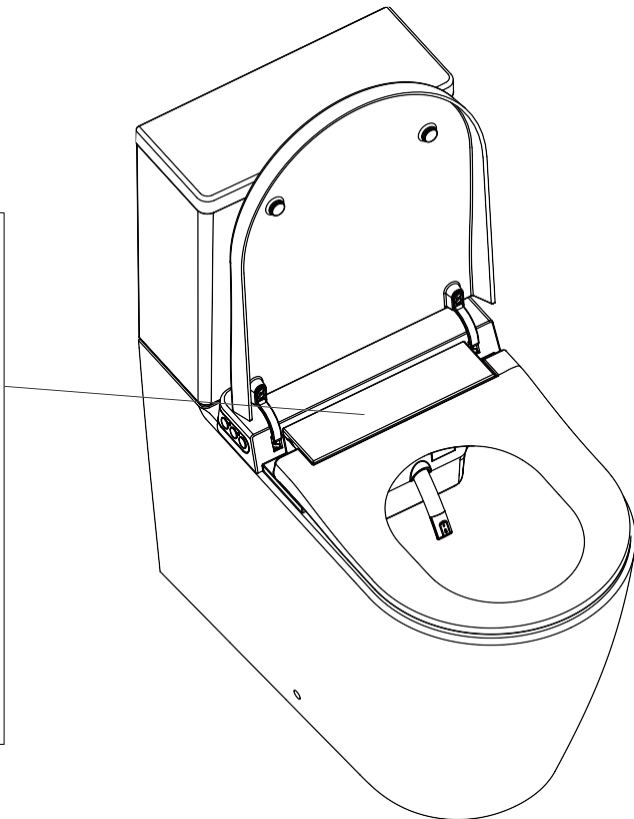

**Do not use the cleaning agents of strong acid and alkali**  
**To clean the E-bidet, do not use the hard brush e.g. toilet brush / nylon brush**

### Self-cleaning the tank

If not used for more than 72 hours, when the seated state is detected, it will open the self-cleaning for about 3 minutes. All the buttons are invalid during the self-cleaning, and it will return to normal after the self-cleaning.

## Descaling the device

- You will need to descale the device at least once a year, or more often depending on the number of shower cycles and the water quality.
- During the descaling procedure, you can continue to use the toilet without the washing functions **and the drying function**
- The descaling process will last for 30 minutes. During this process, the LED will be red and the bidet will make a sound. When descaling is finished, the LED will change to green.
- Do not use descaling agents which can foam.



## NOTICE

Damage to human body and the device from aggressive descaling agents.

### 1. Open the lid

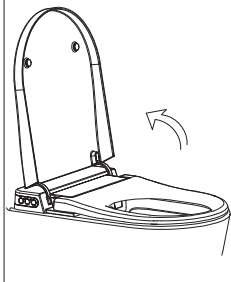

### 2. Open the decorative cover

a). Open the decorative cover, the buzzer sounds "B", and water flows out from the nozzle position.  
 b). The product's internal water tank is refilled with water, and the digital display shows "dE". After the water is filled, the product begins to drain, and the digital display shows "d2".



c). After draining the water, display d3, and there are two beeps of "BB" indicating the addition of descaling agent for five minutes. If no descaling agent is added within five minutes, the descaling process will automatically exit, or you can manually cover the descaling cover to exit the descaling process.

### 3. Open the rubber cover and add descaling agent

Open the rubber cover and add descaling agent. When a "B" sound appears, stop adding descaling agent when prompted, display d4.

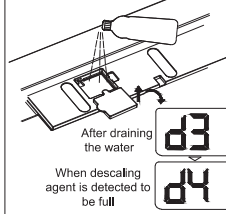

### 4. Cover with rubber cover and decorative cover

Start descaling for 20 minutes.

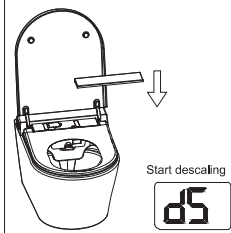

### 5. End of descaling

The descaling process is complete and displays d6. Drainage begins and ends a few minutes later. Restore the display screen to its pre descaling state.

displays d6



## Deodorization filter replacement

- The lifetime of deodorization filter is about 12 months, which would be affected by different using environment.
- Please pay attention to the installation direction when replace a new deodorization filter.

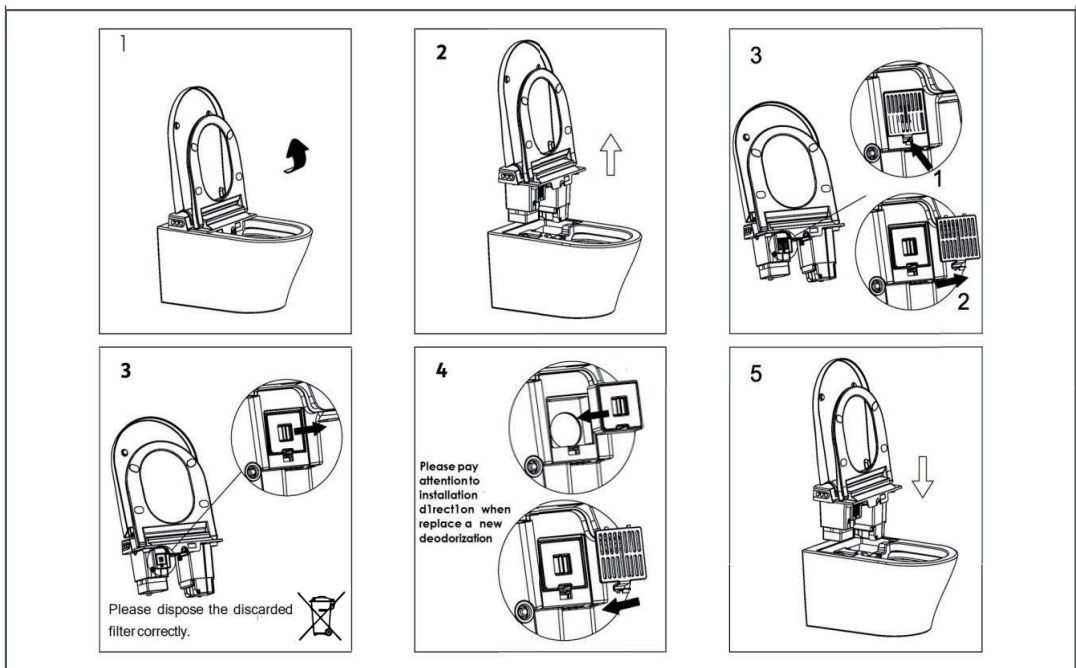

## Factory data reset

1. Take out the battery and press any button to consume the remaining power of the remote control.

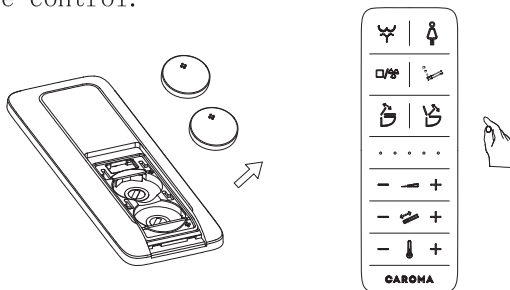

2. Reinstall the battery. After the battery be installed, all 5 indicator lights of the remote control will be on.

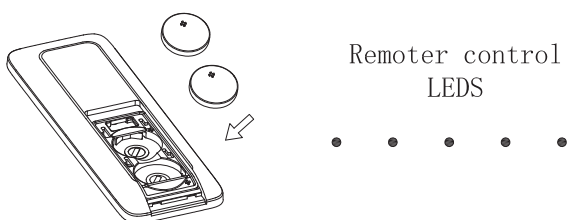

3. Press "stop" button of the remote control until indicator lights up and then off successively.

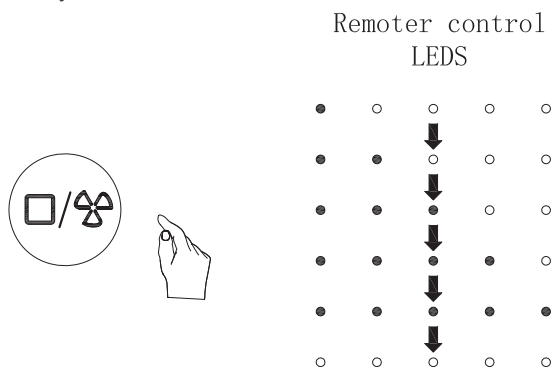

4. There is "beep" sound from the bidet, which means complete factory data resetting process.



NOTICE

- Batteries cannot be inverted.
- Please complete the operation within 15s after reinstalling the battery, during the process press any button of the remote control to exit "factory reset".

## Replacing remote control batteries

**The remote control requires two batteries (3V CR2032). Not provided**  
**When the user lights flash continuously, replace the batteries.**

1. Do not attempt to recharge non-rechargeable batteries.
2. Rechargeable batteries are to be removed from the appliance before being charged.
3. Different brands of batteries or new and used batteries should not be mixed.
4. Ensure batteries are inserted with the correct polarity.
5. Flat batteries are to be removed from the appliance and disposed off safely.
6. Remove the batteries if the appliance is to be stored unused for a long period of time.

### WARNING



#### WARNING

- Battery is hazardous and is to be kept away from children (whether the battery is new or used)
- Battery can cause severe or fatal injuries in 2 hours or less if it is swallowed or placed inside any part of the body.
- Medical attention should be sought immediately if it is suspected the battery has been swallowed or placed in any part of the body.
- The supplied remote control has been tested and complies with the requirements of AS/NZS 62368.1: 2018, consumer goods (products containing button/coin batteries) safety standard 2020.
- Do not use recycled water.

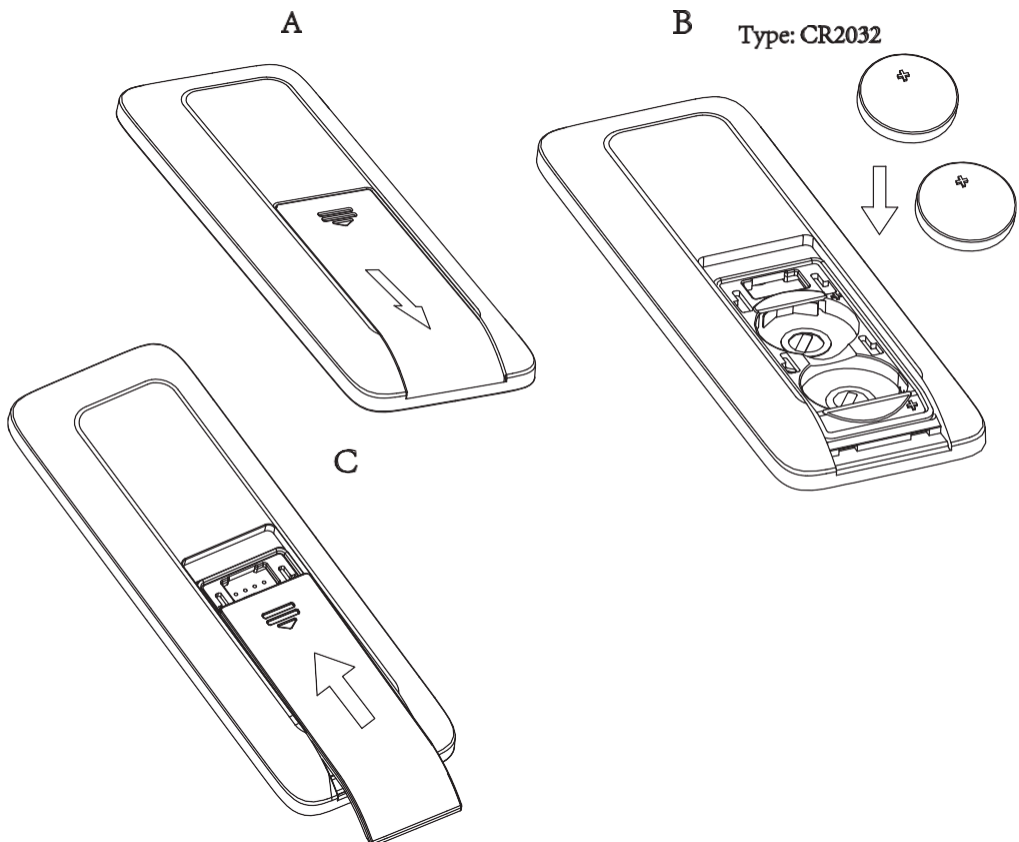

# Troubleshooting

Problem	Potential cause	Suggested action
Not washing	The power supply may not be ON.	Turn ON the power.
	The water supply may not be opened.	Open the water inlet valve to ensure there is a water supply.
	The filter (if used) may be blocked.	Replace it with a new filter. Service life is approx. 6 months.
	User may not be sitting on seat.	Sit on the seat and adjust sitting position (bidet will not operate if it cannot detect a user).
	Cover may be closed.	Open the cover and sit on the seat.
	May not have been used for more than 72 hours.	If not used for more than 72 hours: When the user sits down, it will execute the self-cleaning function for approx. 3 minutes. All buttons are inactive during this function and will return to normal once complete.
The nozzle goes back suddenly	The washing cycle is 3 Minutes at Constant Temperature mode and 1 minute at Gradual Cooling.	This is normal; press the "Wash" button to restart washing function.
	There may be a problem with the water supply.	Check if there is a water outage in the area.
	The seat sensor may be detecting that the user is no longer sitting.	Adjust sitting position.
	The cover may be attempting to close.	Do not put down the cover while it is washing.
Low water flow rate	The water flow rate may be set to Low.	Increase the flow rate as per "Adjusting Water Flow Rate" chapter of instructions.
	The water supply pressure may be too low.	Please check and ensure the water supply pressure is $\geq 0.5$ bar (dynamic pressure).
	The filter (if one is used) may be blocked.	Replace it with a new filter. Service life is approx. 6 months.
	The nozzle may be blocked.	Replace with a new nozzle.
Low water temperature	The water temperature may be set to Low.	Increase the water temperature as per "Adjusting Temperature" chapter of instructions.
	The temperature of water supply may be too low.	Increase the water temperature as per "Adjusting Temperature" chapter of instructions or decrease the Flow Rate as per "Adjusting Water Flow Rate" chapter of instructions.
	The water thermostat is OFF.	Reset the thermostat as per "Resetting Thermostat" chapter of instructions.
The nozzle extends slowly	When performing Wash function, the nozzle will self-clean before extending and may take some time.	This is normal.
Water flows out of nozzle but nozzle does not extend automatically	When performing Wash function, the nozzle will self-clean before coming out and may take some time.	This is normal.
	May not have been used for more than 72 hours.	This is normal. If not used for more than 72 hours and the user sits down, it will execute the self-cleaning function for approx. 3 minutes.
The Dryer will not work	The power supply may be OFF.	Turn ON the power.
	User may not be detected.	Sit on the seat and adjust sitting position.
	The cover may be closed.	Open the cover and sit on the seat.
	May not have been used for more than 72 hours.	If not used for more than 72 hours: When the user sits down, it will execute the self-cleaning function for approx. 3 minutes. All buttons are inactive during this function and will return to normal once complete.
Low air temperature	The air temperature may be set to a low setting.	Increase the air temperature as per "Adjusting Temperature" chapter of instructions.
	The air heater is not heating.	Contact local distributor.
Night Light is always OFF	Bidet seat is installed in a bright environment.	When the Night Light is set to Smart Mode, the Night Light feature will not work when located in a bright environment.
	The Night Light function may be OFF.	Open the Night Light function and adjust the Night Light mode as per "Setting Night Light" chapter of instructions.
Night light is always ON	Bidet seat is installed in a dark environment.	When the Night Light is set to Smart Mode, the Night Light feature will not work when located in a dark environment.
	An object may be covering the sensor.	Remove any obstructions around the sensor.
	The Night Light may be set at 'Always ON' mode	Adjust the Night Light mode as per 'Setting Night Light' chapter of instructions.
The nozzle goes back automatically during manual cleaning	The nozzle goes back after washing 5 minutes.	This is normal.
	Press the "STOP" button.	Manual Cleaning will stop if the 'STOP' button is pressed on the remote control.
Remote control not working	No batteries in the remote control	Install the correct batteries in the remote control.
	Battery power is too low.	When the battery power is low the LED grade will flash. Replace the batteries.
	The Bidet code and remote-control codes are not the same.	Set the remote-control code to the correct one. See 'Remote Control Pairing Setting' chapter in instructions.
There are BEEP sounds when the bidet is working	There is a short BEEP when you are sitting down, and a long BEEP when you leave. There is also a short BEEP when the bidet receives a command.	This is normal. You can turn OFF the sound. Refer to 'Sound Setting' chapter in instructions.
The bidet is not operating normally		Shut OFF the power and turn ON after one minute. If the bidet still does not work, contact local distributor.
The light on the body flash 6 times and constantly beeps	The Water Supply Temperature may be too high.	Shut OFF the power and water supply, stop using the product and contact the local distributor.
The light on the body keeps flashing		Check if the electrical power and water supply are working as normal, switch OFF the power and restart the product. If the bidet still will not work, please contact the local distributor.

# Troubleshooting

## LED Fault Indication

Fault Indication	Fault
LED: 1 flash NO Beep	1.Heating element switch faulty.
LED: 2 flashes Continuous Beep	2.outlet water temperature above 45°C Continuous Beeping until temperature drops to 45°C.
LED: 3 flashes Continuous Beep	3.Dryer temperature above 55°C Continuous Beeping until temperature drops to 45°C.
LED: 4 flashes Continuous Beep	4.Seat temperature above 55°C Continuous Beeping until temperature drops to 45°C
LED: 5 flashes NO Beep	5.Level sensor failure or no water in tank.
LED: 6 flashes NO Beep	6.Tank refill too slow
LED: 7 flashes NO Beep	7. Tank drain too slow
LED: 8 flashes NO Beep	8. Water outlet thermistor faulty
LED: 8 flashes NO Beep	9. Dryer thermistor faulty
LED: 8 flashes NO Beep	10. Seat thermistor faulty
LED: 9 flashes NO Beep	11. Communication faulty

Status LED

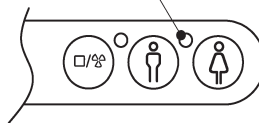

If you should encounter an issue with operation/function of your product, please contact Customer Service.

To assist in the resolution, we will require your Serial number, a video of the issue, including operation of the remote or dial, position of the seat, video of the side control and sound to indicate any beeps which occur, this will give a full picture of the operation to help determine the best resolution or guidance.

## Fault Warning Codes of 300071W/300095W

Code	Description
01E	Power supply fault
02E	Temperature of inlet water is too high
03E	Temperature of outlet water is too high
04E	Air temperature is too high
05E	Seat temperature is too high
06E	Liquid level sensor fault
07E	Overtime of tank water inlet (water inlet fault) *
08E	Overtime of water pump water outlet
10E	NTC of outlet water temperature fault (NTC thermistor)
11E	NTC of air temperature fault (NTC thermistor)
12E	NTC of seat temperature fault (NTC thermistor)

\* The reason may be insufficient inlet water/ flex hose get folded/ filter get blocked



# CAROMA



**GWA**  
Bathrooms & Kitchens

**Australia**  
Caroma Industries Ltd  
ABN 35 000 189 499  
1 Melito Court, Prestons NSW 2170  
Customer Care Phone: 13 14 16  
[www.caroma.com.au](http://www.caroma.com.au)  
[www.methven.com](http://www.methven.com)

**New Zealand**  
GWA Group (NZ) Ltd  
NZBN 9429040452203  
41 Jomac Place, Avondale, New Zealand  
Customer Care Phone: 0800 804 222  
[www.caroma.co.nz](http://www.caroma.co.nz)  
[www.methven.co.nz](http://www.methven.co.nz)



